

# SET UP INSTRUCTION

## Expolinc Frame

### BASIC

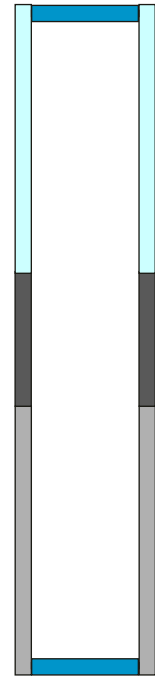
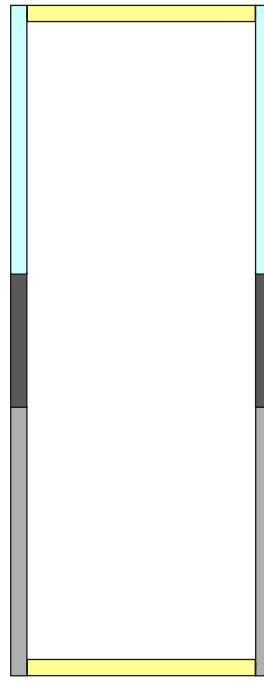
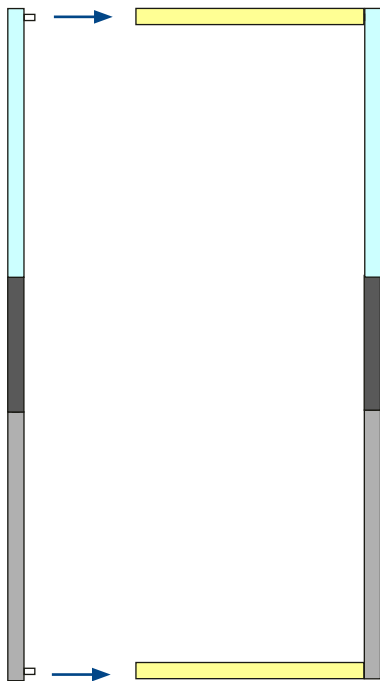
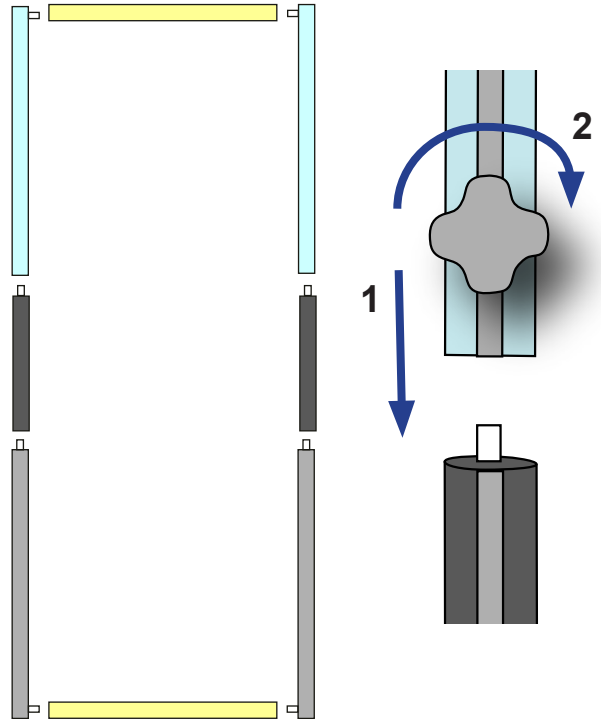
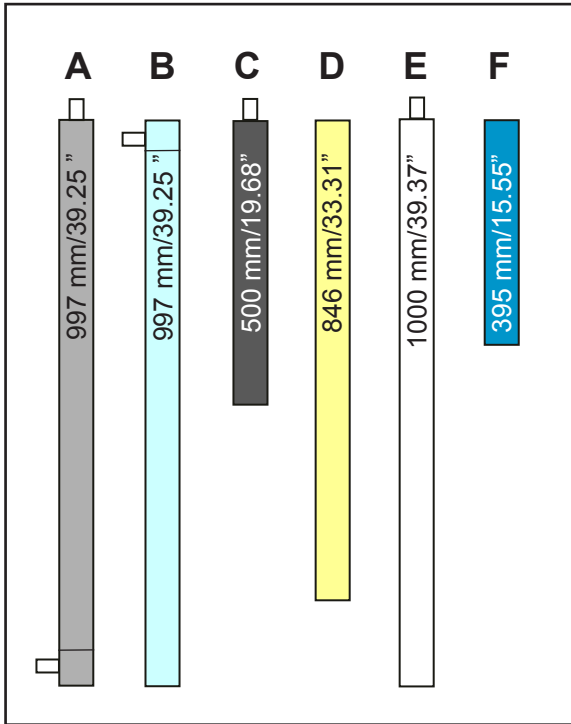

# WIDTHS & HEIGHTS

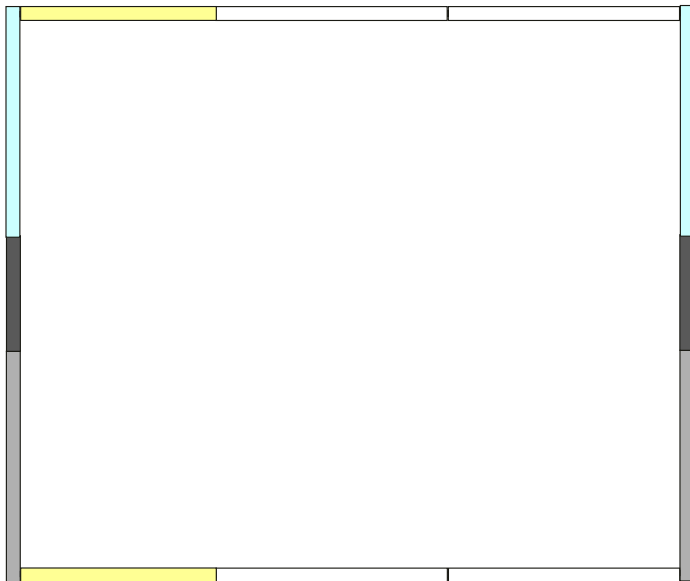
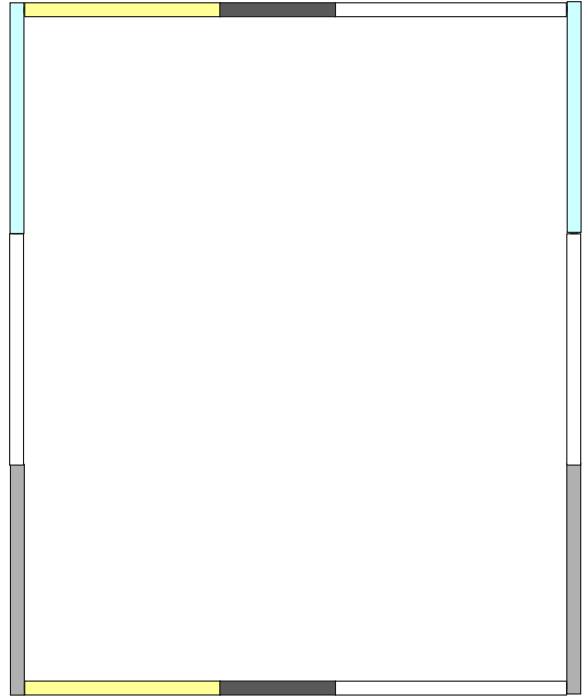
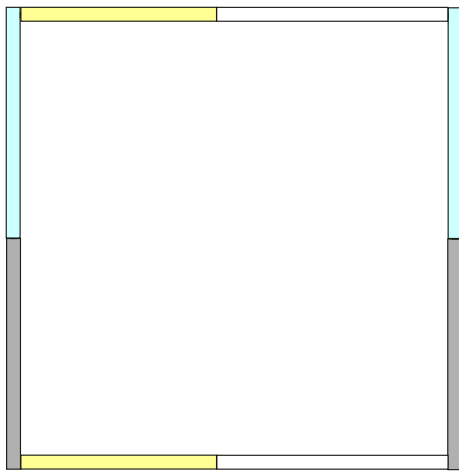
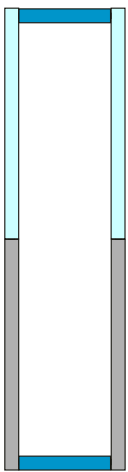
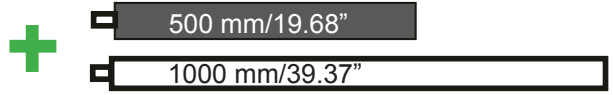

# SUPPORTING ROD

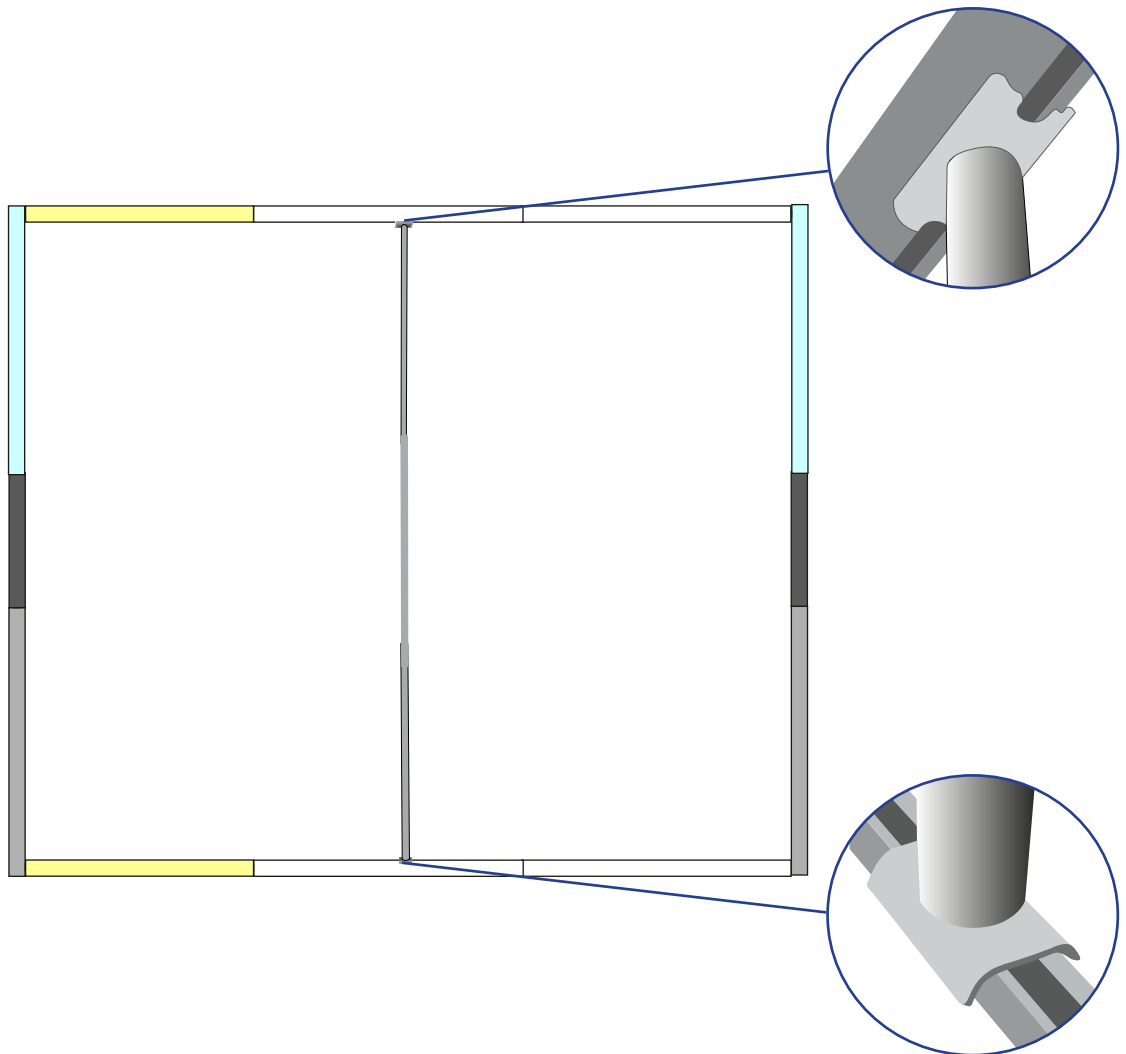
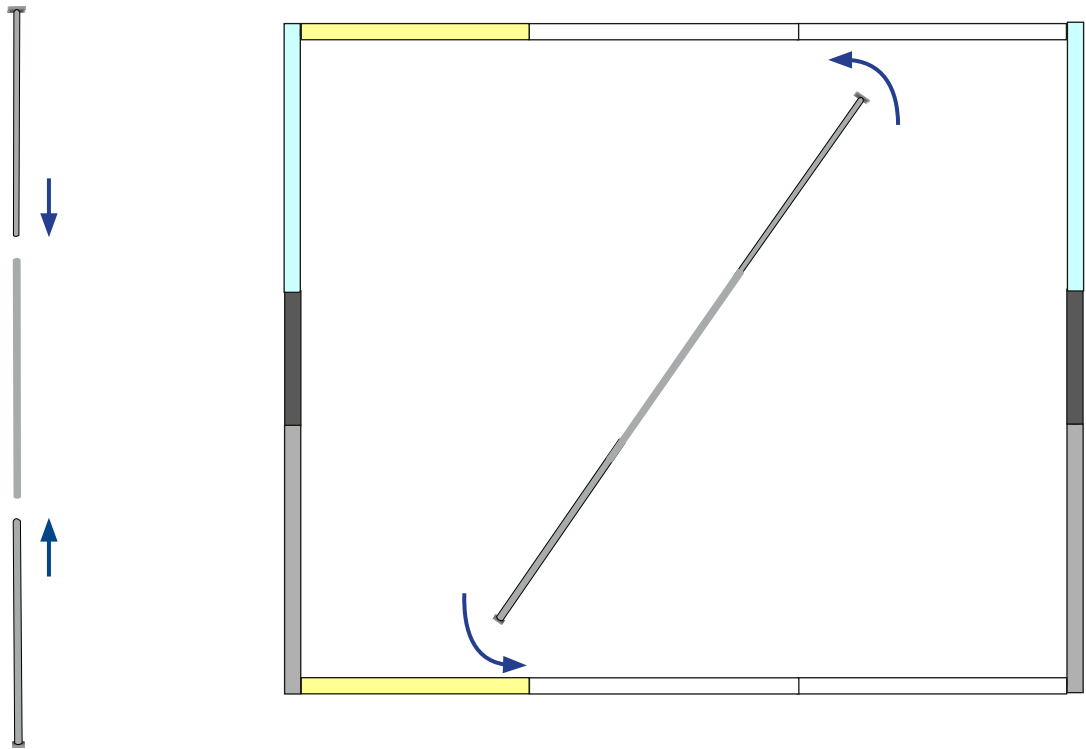

# MOUNT THE GRAPHIC

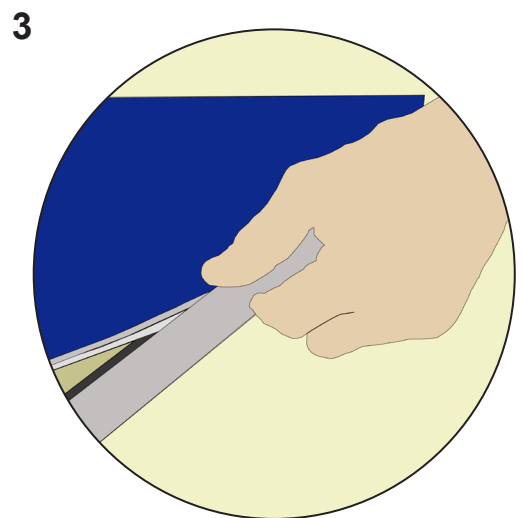
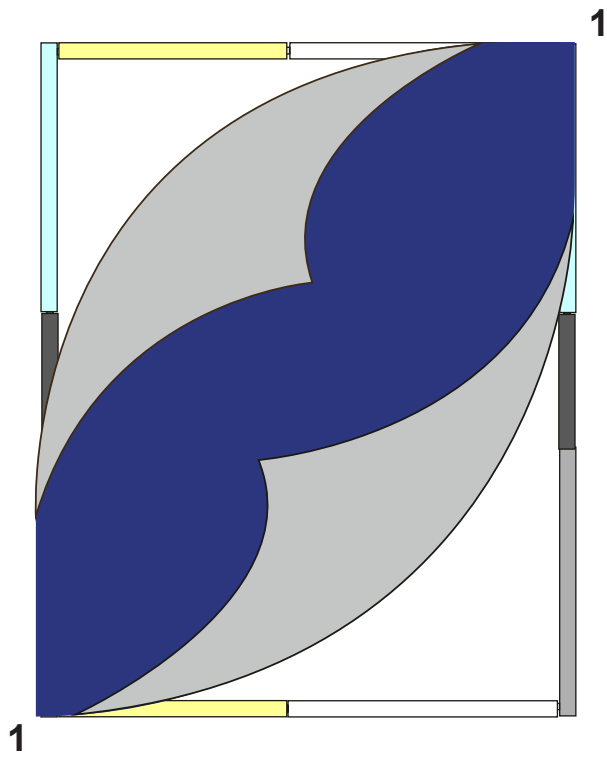

# STABILIZING FOOT

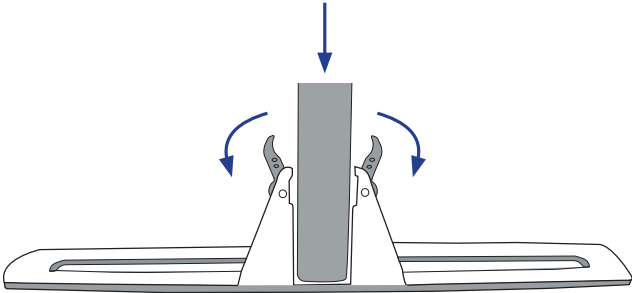

## Standard foot

Double-sided

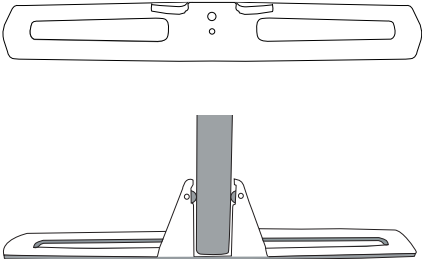

Single-sided

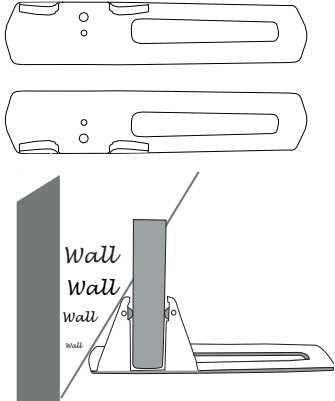

Standard foot      Standard foot

## Connecting foot

Double-sided

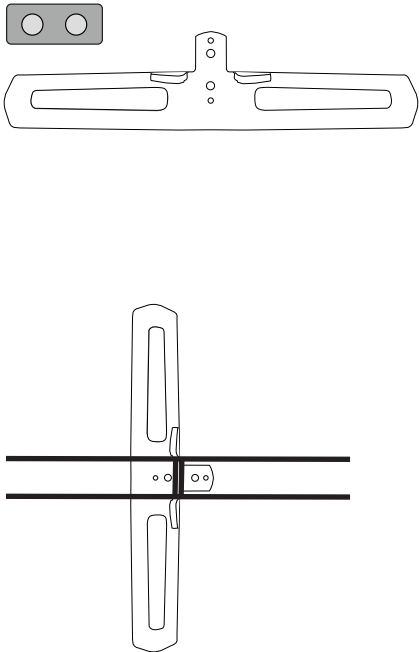

Single-sided

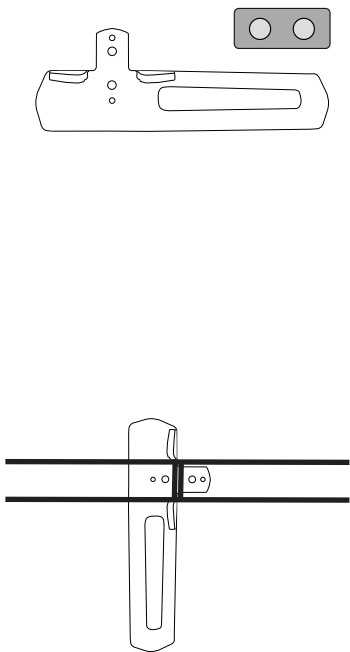

Standard foot      Connecting foot      Standard foot

# CONNECTORS

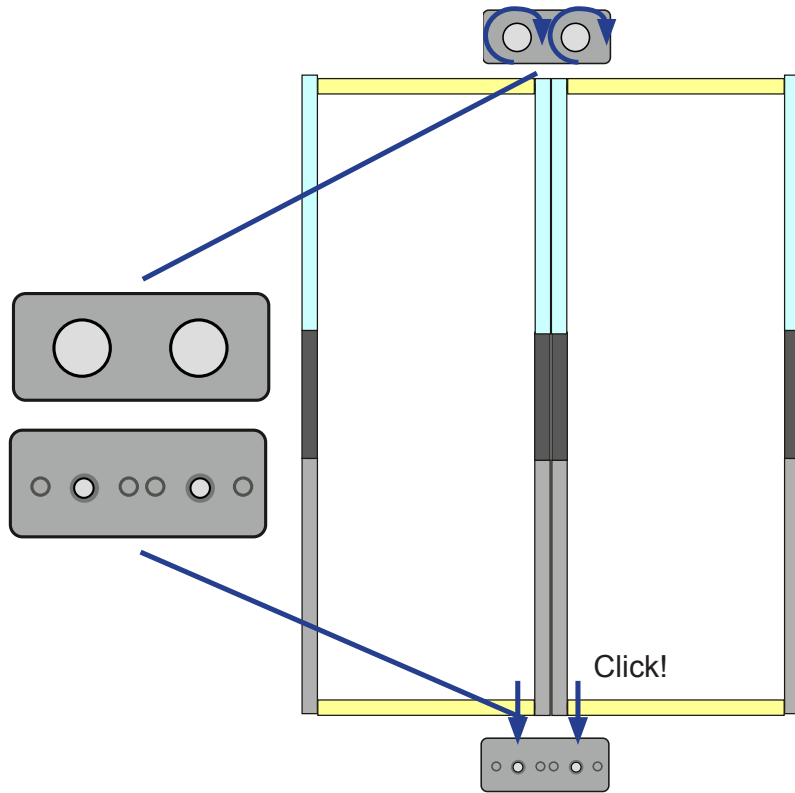

90° type A

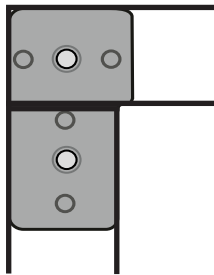

90° type B

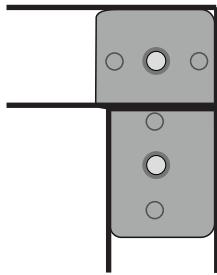

Straight

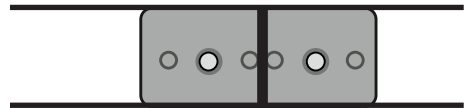

Triple A

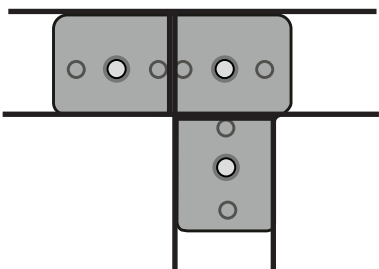

Triple B

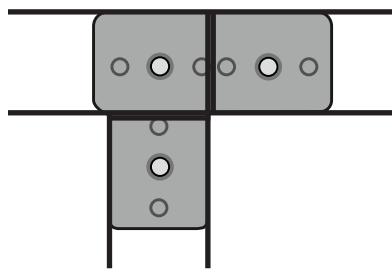

Triple C

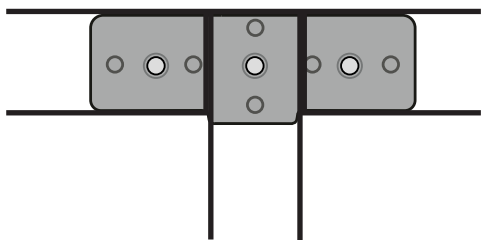

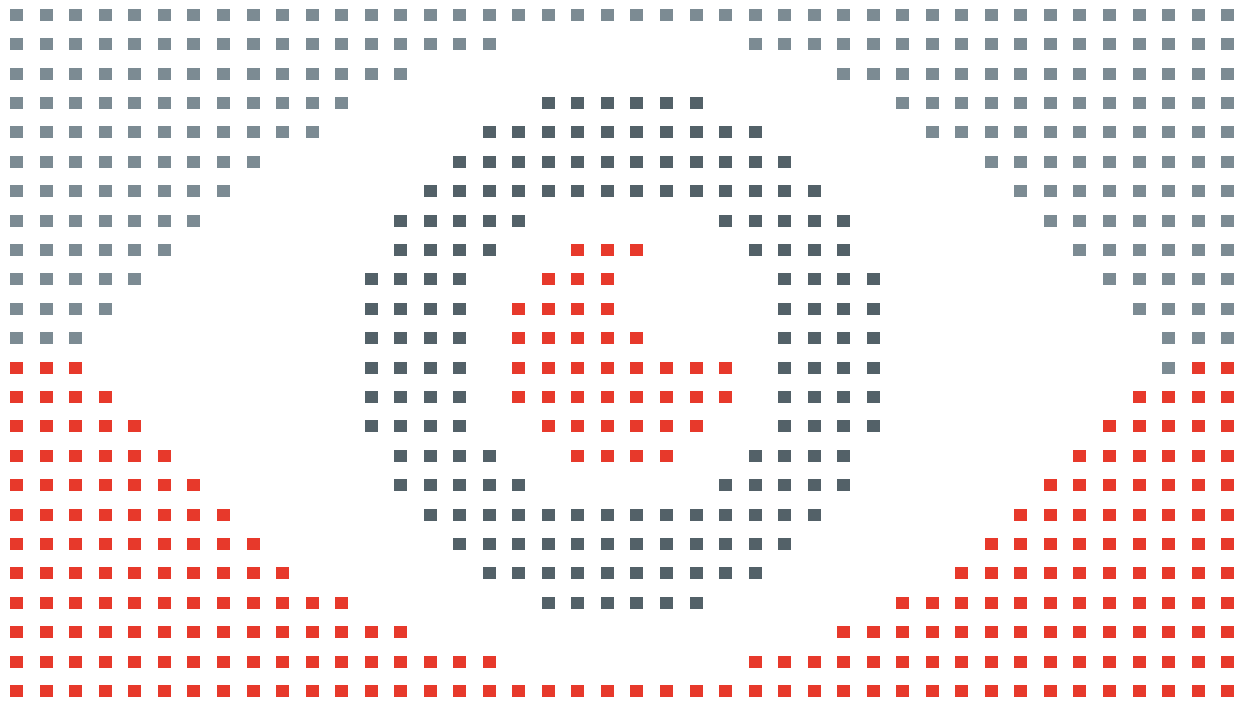

WEIDE  
DISPLAYS

Bei Fragen, einfach anrufen: **040/66 93 06-0**

WEIDE Displays GmbH | Braaker Grund 2 | 22145 Braak-Hamburg | [www.weide-displays.de](http://www.weide-displays.de)